

**VRO 300T™**

---

REFERENCE MANUAL

***ACU-RITE®***







---

# Readout Parameter Access Code

An access code must be entered before machine-related parameters can be set or changed. This prevents inadvertent adjustments to the setup parameters.

## IMPORTANT

**The access code is 8891**

Refer to the Setup section. Begin by pressing the  key, then the  softkey. Press the , , , , and  keys. The readout is now ready for machine parameter setting operations.

## IMPORTANT

Supervisors may wish to remove this page from the Reference manual after initially setting up the readout system. Retain in a safe place for future use.



## **Warranty**

ACU-RITE Products and accessories are warranted against defects in material and workmanship for a period of three years from the date of purchase. ACU-RITE will, at its option and expense, repair or replace any part of the ACU-RITE product that fails to meet this warranty. This warranty covers both materials and factory labor. In addition, authorized ACU-RITE service representatives will provide service labor (field service) for a period of one year at no charge. Notice of the claimed defect must be received by ACU-RITE within the warranty period.

This warranty applies only to products and accessories installed and operated in accordance with this reference manual. ACU-RITE shall have no obligation, with respect to any defect or other condition caused in whole or in part by the customer's incorrect use, improper maintenance, modification of the equipment, or by the repair or maintenance of the product by any person except those deemed qualified by ACU-RITE.

Responsibility for loss of operation or diminished performance due to conditions beyond ACU-RITE's control cannot be accepted by ACU-RITE.

The foregoing warranty obligations are in lieu of all expressed or implied warranties. ACU-RITE INCORPORATED shall not be liable under any circumstances for consequential damages.

### **30 Day Red Carpet Warranty**

All ACU-RITE products are covered by a 30-day Red Carpet Warranty. If in the first 30 days this product fails for any reason, repack it in the original packaging materials and contact your Authorized ACU-RITE Distributor for return procedures.

<b>Introduction .....</b>	<b>1</b>
<b>A Tour of the Readout .....</b>	<b>1</b>
Front and Back Views.....	1
Connections.....	2
<b>Keypad.....</b>	<b>3</b>
<b>Display .....</b>	<b>4</b>
Readout and Program Displays.....	5
<b>Power-On Position Recovery .....</b>	<b>6</b>
Position-Trac .....	6
<b>Readout Operations.....</b>	<b>7</b>
<b>Clear Key .....</b>	<b>7</b>
<b>Absolute and Incremental Displays .....</b>	<b>7</b>
Absolute Display .....	7
Incremental Display .....	7
<b>Radius / Diameter Displays.....</b>	<b>8</b>
<b>Zeroing the Displays .....</b>	<b>9</b>
Absolute Zero .....	9
Incremental Zero.....	12
<b>Presetting.....</b>	<b>13</b>
Absolute and Incremental Presets .....	14
Presetting Using the POS Key.....	14
<b>Near Zero Warning .....</b>	<b>15</b>
<b>Tool Offsetting .....</b>	<b>16</b>
<b>Program Operations .....</b>	<b>17</b>
<b>Creating a Program .....</b>	<b>17</b>
<b>Tool Steps .....</b>	<b>18</b>
<b>Position Steps.....</b>	<b>19</b>
<b>Saving and Loading Your Programs .....</b>	<b>20</b>
Alphabet Entry .....	21
<b>Running a Program .....</b>	<b>22</b>
Tool Steps .....	22
Position Steps.....	22
<b>Teaching a Position.....</b>	<b>23</b>
<b>Other Features .....</b>	<b>24</b>
<b>Calculator .....</b>	<b>24</b>
<b>Printing.....</b>	<b>27</b>
<b>Remote Interface .....</b>	<b>29</b>
Requesting Information.....	29
Keypad Commands.....	30
<b>Job Clock .....</b>	<b>31</b>
<b>Reference Tables.....</b>	<b>31</b>

<b>Setup .....</b>	<b>32</b>
<b>Job Setup .....</b>	<b>33</b>
Setting Up the Tool Library .....	33
Defining Tools with Auto-Offset .....	33
Display Resolution .....	35
Near Zero Warning .....	35
Linear Error Compensation .....	36
Anchoring the Segments .....	37
Compensation Entry Methods .....	38
Feed Rate Units .....	41
Remote Switch .....	41
Vectoring .....	42
Scale Factor .....	43
Job Clock .....	43
<b>Installation Setup .....</b>	<b>44</b>
Display Configuration .....	44
Encoder Setup .....	45
Serial Port .....	46
Parallel Port .....	47
Protection .....	47
<b>Installation .....</b>	<b>48</b>
<b>Readout Specifications .....</b>	<b>50</b>
<b>Troubleshooting .....</b>	<b>51</b>



This symbol alerts you to the fact that important information concerning the installation and operation of this readout has been included in this manual.

Keep these instructions in a secure place for future reference.

## Introduction

ACU-RITE's VRO 300 readout series provides the application-specific features required for you to obtain the most productivity from your manual machine tools.

The VRO 300T is designed specifically for turning applications. Special features include tool offsetting, axis lock (hold), programming, and vectoring.

### A Tour of the Readout

#### Front and Back Views

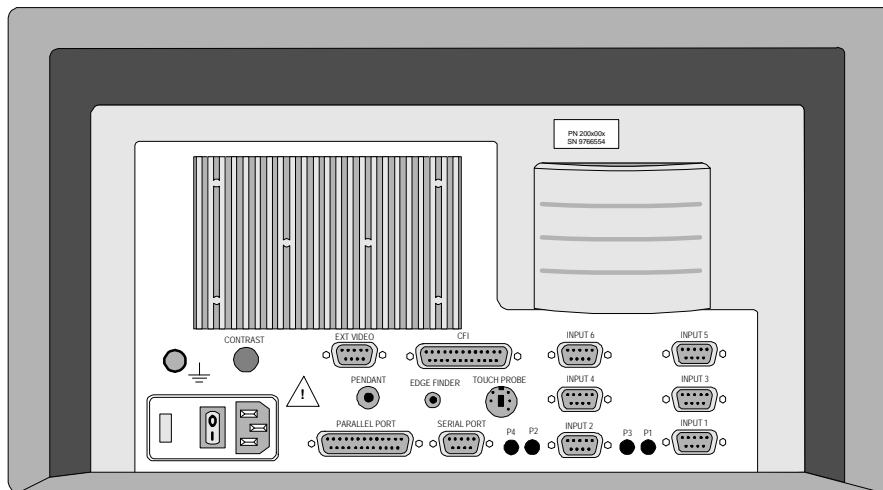
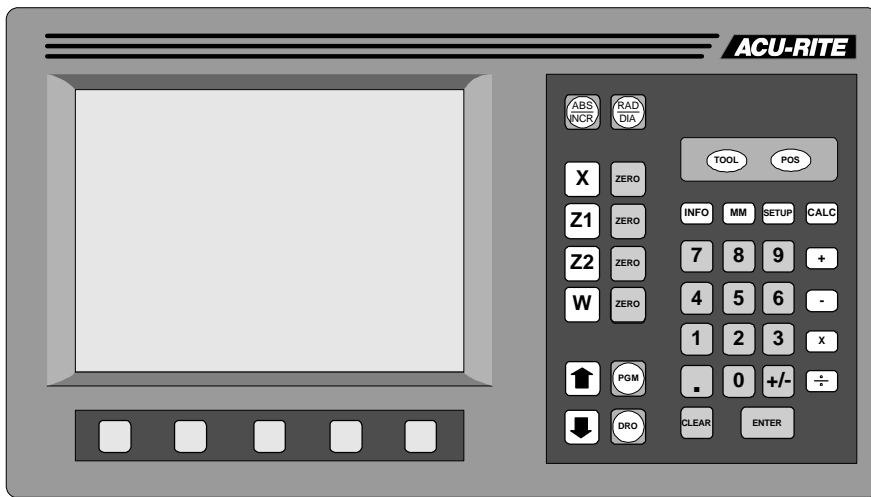



Connections

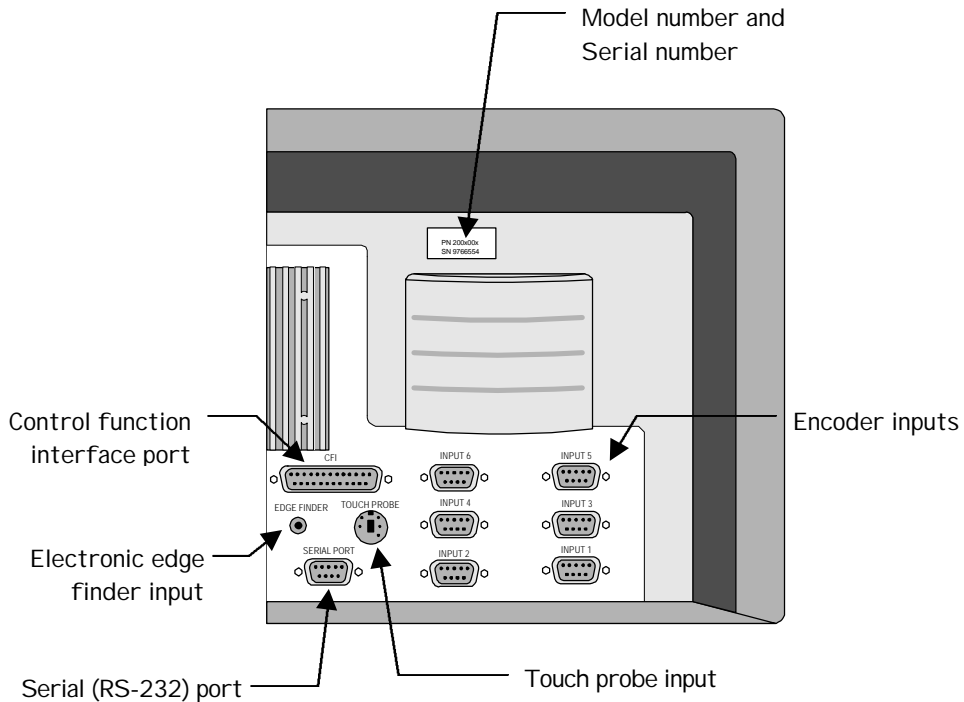
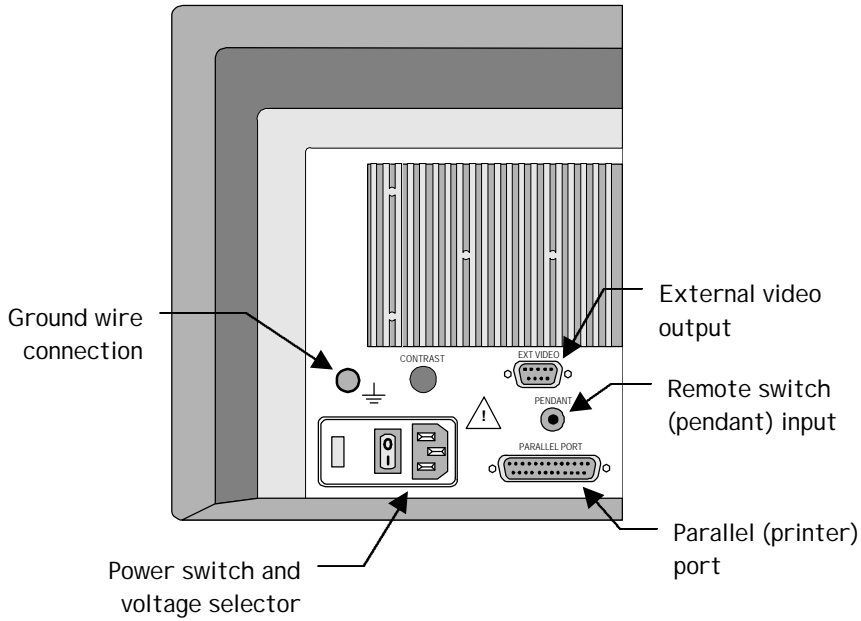

### Keypad

Selects absolute or incremental display



Selects radius or diameter display

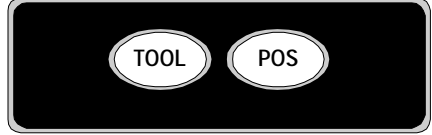

Application-specific function keys

System information and help



System setup parameters

English / metric conversion

Begin a preset



Zero an axis



Enter all numeric values with these



Handy calculator functions

Move up or down on the screen



Lets you switch between programming and Digital ReadOut displays



## Display

The 9" CRT display screen is divided into four sections.

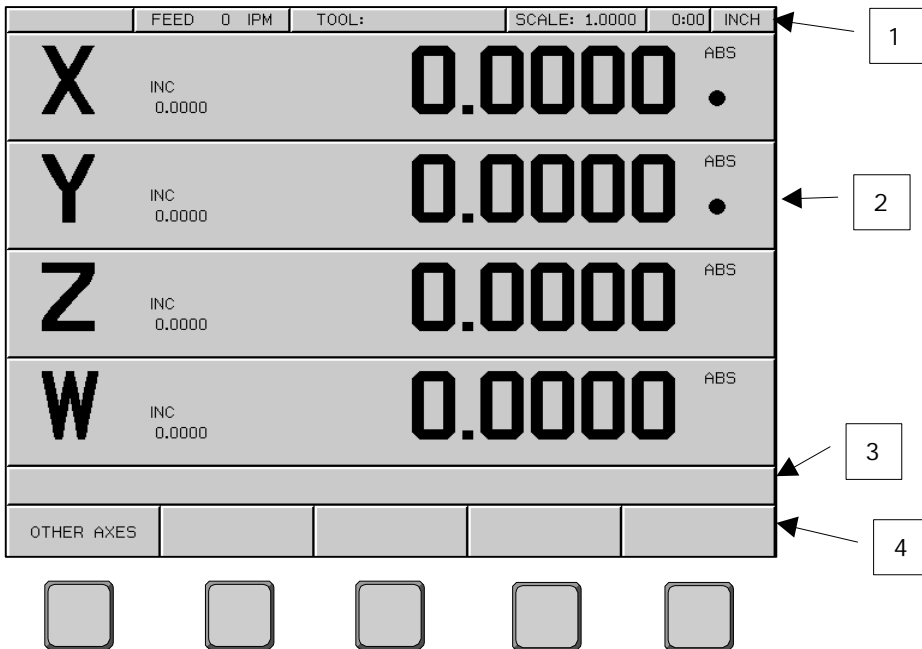

- 1 — Status bar – displays the feed rate, current tool, scale factor, the job clock, and inch/mm status.
- 2 — Information screen – displays information for the task being performed.
  - Used as a readout, the screen will display the current position for each axis.
  - When programming, the program steps will be displayed.
- 3 — Message line – operator prompts and messages will appear here.
- 4 — Softkeys – variable functions appear here; functions are selected by pressing the hard key directly below the softkey.

### Readout and Program Displays

The  and  keys switch the display between the digital readout (DRO) display and the program (PGM) display.

In the DRO display, all standard readout operations are available. The display can show up to four axis positions simultaneously. If you use more than four, press the  softkey to view the other axes. Softkeys for zeroing and presetting these other axes will also appear.

In the PGM display, you can create and run programs. Many of the readout operations are still available. All six possible axis positions can be displayed at the same time in this view.



FEED 0 IPM		TOOL # 02	SCALE: 1.0000	0:53	INCH
<b>X</b>	INC 2.0000		<b>0.3540</b>	ABS	DIA
<b>Z<sub>1</sub></b>	INC 2.0000		<b>2.0000</b>	ABS	
<b>Z<sub>2</sub></b>	INC -0.2500		<b>0.0000</b>	ABS	



FEED 0 IPM		TOOL # 02	SCALE: 1.0000	0:53	INCH
CURRENT PROGRAM					
001 SET TOOL	<b>X</b>	INC 2.0000	<b>0.3540</b>	ABS	DIA
002 POSITION					
003 POSITION					
004 POSITION	<b>Z<sub>1</sub></b>	INC 2.0000	<b>2.0000</b>	ABS	
005 SET TOOL					
006 POSITION	<b>Z<sub>2</sub></b>	INC -0.2500	<b>0.0000</b>	ABS	
007 POSITION					
END OF ?					
PROGRAM FUNCTIONS	CLEAR PROGRAM				RUN

## Power-On Position Recovery

### Position-Trac

Certain ACU-RITE encoders, such as the ENC 150, contain closely-spaced reference marks that enable the display to show the correct position after a power interruption. The readout will indicate when power has been lost, and will prompt you to move each axis until a reference mark is located. By traversing the reference marks once in each axis, you will re-establish the display position relative to the last known zero. The most you will ever have to move an axis is about one inch. You must move in a positive count direction.

If you use an encoder that does not have the Position-Trac feature, the procedure for recovering your position is slightly different. Reference marks on these encoders are about 8 inches apart. You must find a convenient reference mark and then use the same mark every time.

1. Move near the desired reference mark.
2. Press the  key.
3. Move slowly past the reference mark until the readout recalls its position. You must move in a positive direction.

## Readout Operations

### Clear Key

Use the  key to erase digits that you have entered by mistake or to take you back if you've pressed an incorrect function key.

### Absolute and Incremental Displays

#### Absolute Display

Shows the distance from your current position to *absolute zero*.

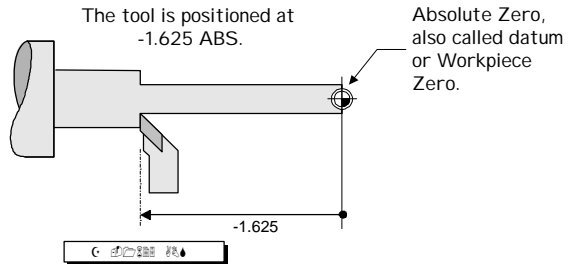

#### Incremental Display

Shows the distance from your current position to the *incremental zero*. An incremental zero is set when you preset a dimension, or when you zero the incremental display.

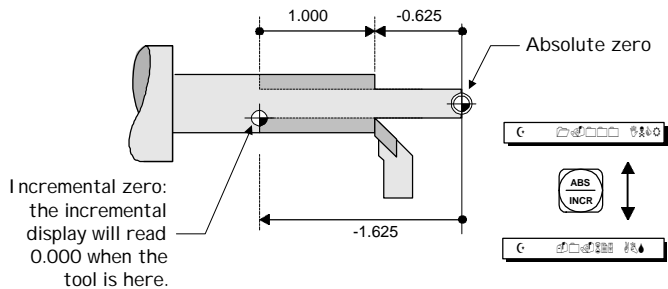

You can always see both absolute and incremental positions at the same time.

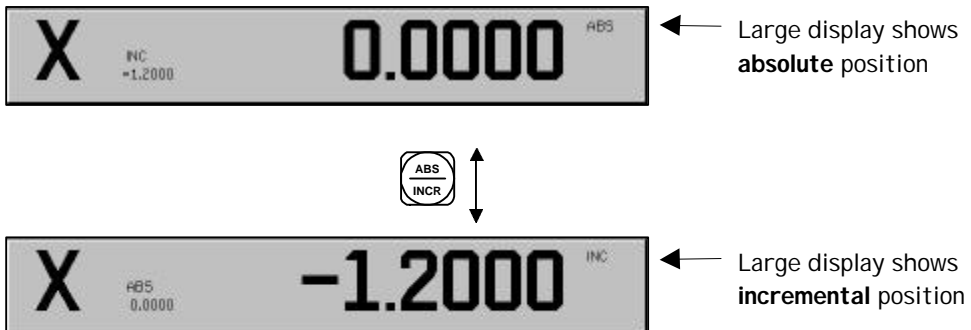

## Radius / Diameter Displays

Pressing the  key lets you view the part dimension either as a radius or as a diameter.

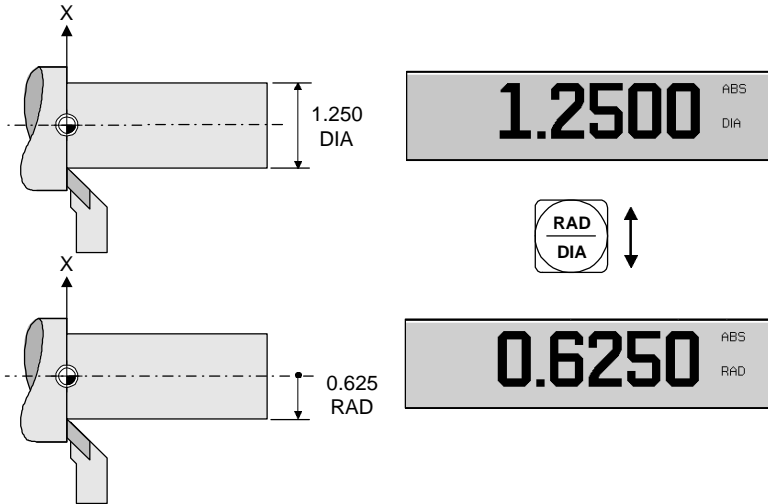

## Zeroing the Displays

### Absolute Zero

On many prints, the dimensions are measured from one or two surfaces of the part. By setting the readout's absolute display to zero at a well-chosen surface, you can enter the part's dimensions directly from the print, using absolute presets.

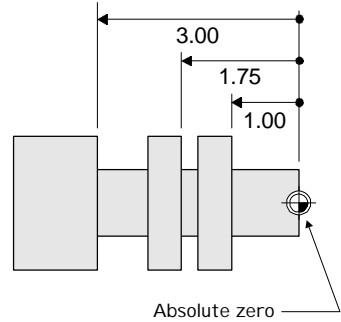

### Setting Absolute Zero at the Current Position

1. Move to desired location.
2. Make sure that the absolute position is displayed.



3. Zero the appropriate axis.



Shortcut



### Setting Absolute Zero with a Tool

#### Longitudinal Axis

1. Touch the tool to the face of the workpiece.

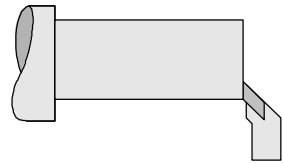

2. Make sure that the absolute position is displayed.



3. Press the **ZERO** key for the appropriate axis.



4. Enter the tool position.



If you want the absolute zero to be on the face of the workpiece:

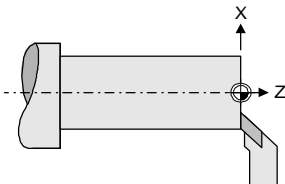

If you want the absolute zero to be offset from the face of the workpiece:

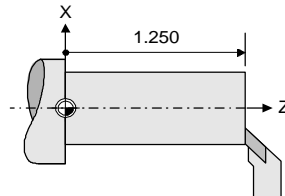



*Crossfeed Axis*

1. Touch the tool to the diameter of the workpiece.

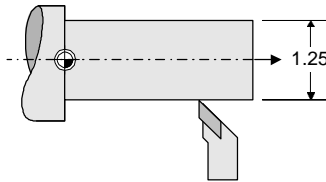

2. Make sure that the absolute position is displayed.



ABS

3. Press the **ZERO** key for the appropriate axis.



4. Enter the tool position—either as a radius or as a diameter, depending on the display.



## Setting Absolute Zero with the Tool under Load

### Longitudinal Axis

1. Make sure that the absolute position is displayed.



ABS

2. Machine the face of the workpiece.

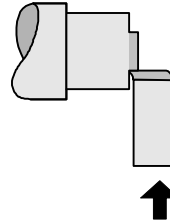

3. While the tool is still contacting the workpiece, press the **ZERO** key for the appropriate axis, then the **LOCK AXIS** softkey. The readout will lock this tool position in the display, even if you move the tool.
4. Move the tool away and measure the face location, if required .

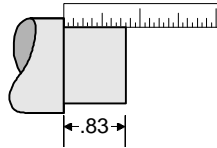

5. Enter the face location.



If you want zero on the face of the workpiece

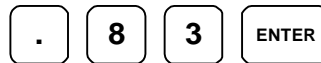
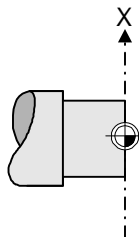

If you want zero offset from the face of the workpiece

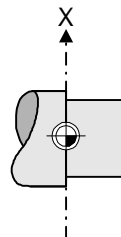

Crossfeed Axis

1. Make sure that the absolute position is displayed.
2. Machine the diameter.

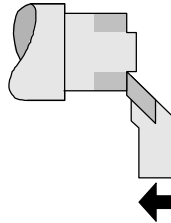

3. While the tool is still contacting the workpiece, press the **ZERO** key for the appropriate axis, then the **LOCK AXIS** softkey. The readout will lock this tool position in the display, even if you move the tool.
4. Move the tool away and measure the diameter.

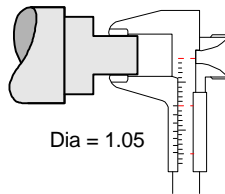

5. Enter the diameter.



This puts the zero on the workpiece centerline

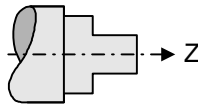

Incremental Zero

From the readout incremental display, press the **ZERO** key. This sets the incremental display to zero at the current tool position.

### Presetting

When you preset a dimension, the readout places an incremental zero at the location you specify. Then, the display automatically switches to the incremental display so you can move to zero.

Begin a preset by pressing an axis key ( **X** for example). The information from the previous preset will appear. The display will show you if the preset is absolute or incremental. Use the **ABS/INCR** key to change from one to the other. Enter the dimension you want to preset.

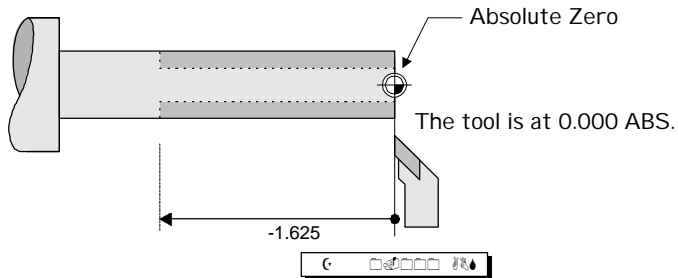
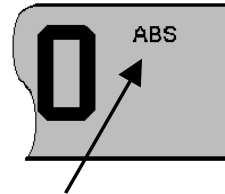

To preset the absolute location of the shoulder:

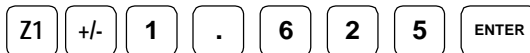

Display automatically switches to incremental.



Absolute display reads zero.

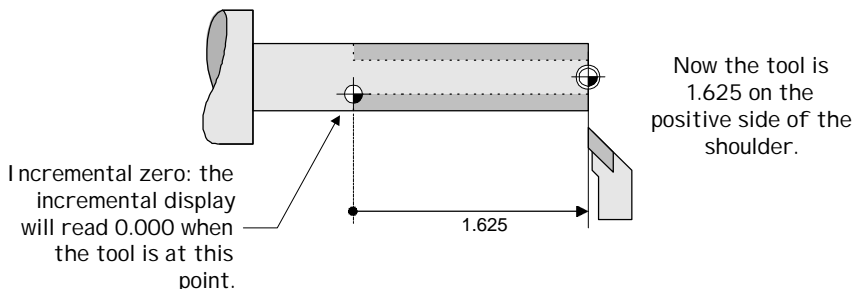

### Absolute and Incremental Presets

To maintain the best tolerance and to minimize the chance for errors, use

- absolute presets for absolute dimensions
- incremental presets for incremental dimensions.

When you enter an absolute preset, it **does not matter** where the tool position is. The VRO 300T calculates the desired location automatically.

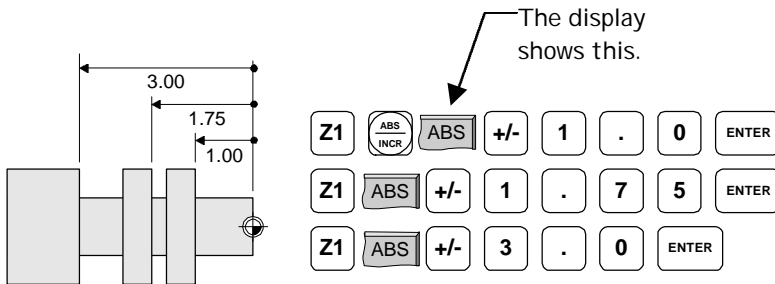

When you enter an incremental preset, the tool **must** be positioned at the place you are dimensioning from.

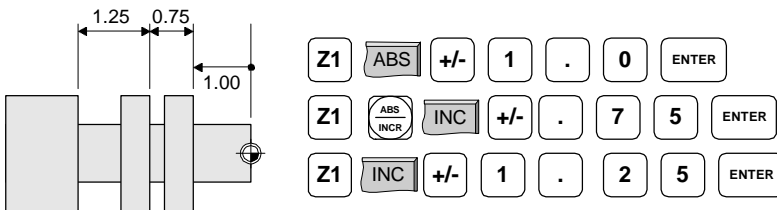

### Presetting Using the POS Key

You can enter a preset using the  key for as many as four axes at once. Refer to page 19 for information on how to complete the Position Step.

When you have completed the position step, press the  softkey to execute the preset operation.

## Near Zero Warning

When you are moving to zero, the readout can “warn” you when you are getting close. This allows you to machine faster and avoid overshooting your desired location.

You can set the near zero range in Setup.

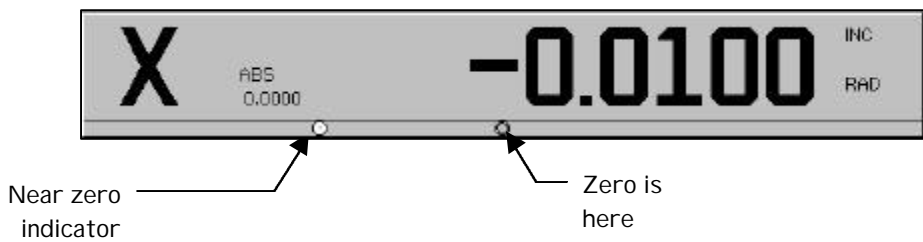
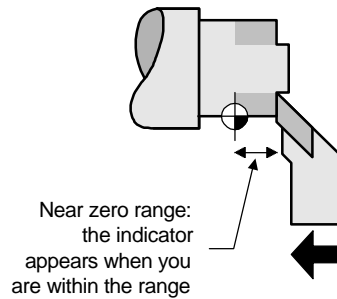

### Tool Offsetting

The VRO 300T can store the dimensional offsets for up to 100 tools. When you change a workpiece and establish the absolute zero, all the tools are automatically referenced to the new zero.

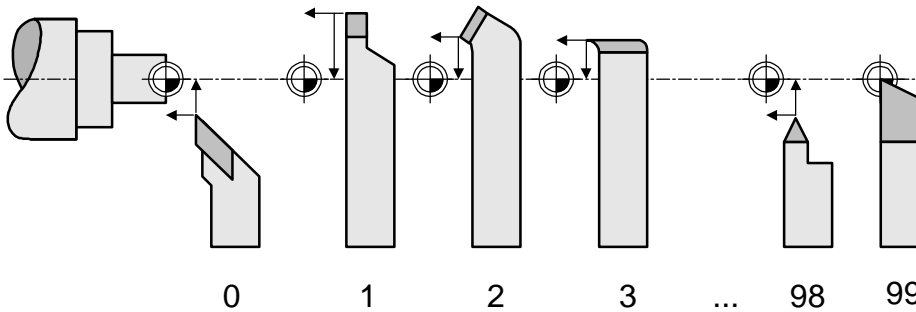

To select a tool, press the **TOOL** key, enter the tool number, and press the **USE** softkey. The new tool number appears in the status bar, and the current position is changed to reflect the new offset values.

If you want to select the tool from the Tool Library, press the **TOOL LIBRARY** softkey, use the arrow keys to move to the desired tool, and press the **ENTER** key to select it.

SET TOOL	
TOOL NUMBER	<input type="text" value="2"/>
OFFSET	
X	-1.2540
Z1	0.5210

## Program Operations









A *program* is a list of tool changes and position presets that you can save for later use.

### Creating a Program

Press the  key, and the program view screen appears.

		FEED 0 IPM	TOOL # 02	SCALE: 1.0000	0:53	INCH
Program Name	CURRENT PROGRAM		<b>X</b> INC 2.0000	<b>0.3540</b>	ABS	
	001 SET TOOL					
	002 POSITION					
	003 POSITION					
Program Steps	004 POSITION		<b>Z<sub>1</sub></b> INC 2.0000	<b>2.0000</b>	ABS	Axis Position Displays
	005 SET TOOL					
	006 POSITION					
	007 POSITION					
	END OF 7					
PROGRAM FUNCTIONS		CLEAR PROGRAM				RUN

You create a program by entering a list of the steps in the order you want to do them.

- To create a new step, press either the  or the  key. Then enter the information describing the step into the form, and press the  softkey to accept the data. This updates the program and moves down for the next step.
- To change a step, use the arrow keys to move to the step, and press  or . When you have made your changes, press the  softkey to accept the changed step back into the program.
- To delete a step, move to the step and press the  key.
- To insert a step, move to where you want the new step to go, and press the  or  key. The new step is inserted and the following steps will move down.

If you decide not to use a step that you have already selected, press the  softkey.





## Tool Steps

Put this step in your program whenever you need to use a different tool. Press the  key to bring up the Set Tool form.

**TOOL**—enter the tool number. When you press , the offset information from the Tool Library is displayed.

**OFFSET**—displays the offset information. You can change this in Setup.

Press the  softkey if you want to select a tool directly from the Tool Library. Use the arrow keys to select the tool, and the  key to put the selected tool into the Tool Step.

SET TOOL	
TOOL	
NUMBER	<input type="text" value="2"/>
OFFSET	
X	-1.2540
Z1	0.5210

### Position Steps

This step lets you program a positioning move. You can preset up to four axes at once. The dimension in each axis can be absolute or incremental.

**POINT**—press an axis key to specify which direction you wish to move. Enter the dimension. If the dimension is incremental, press the **ABS INCR** key and enter the number of the step you want to reference. *The reference step must precede the current step in the program.*

003	POSITION		
POINT	_____		
X	1.000	ABS	
Z1	1.250	INCR	002

Use the arrow keys or the **ENTER** key to move from one axis to another.

### Example

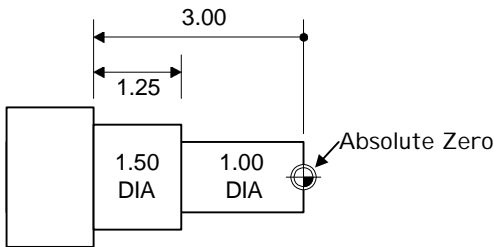

We'll use 2 Position Steps to make this part. This example assumes that the X axis reads in diameter and that Step 001 is a tool step.

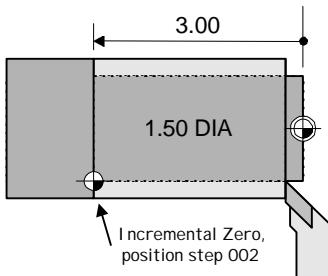

POS **Z1** **+/-** **3** **.** **0** **ENTER**  
**X** **1** **.** **5** **USE**

This becomes Step 002. It will be the reference step for Step 003.

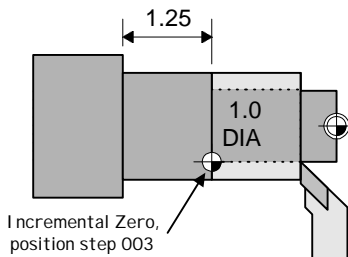

POS **Z1** **1** **.** **2** **5** **ABS INCR** **2** **ENTER**  
**X** **1** **.** **0** **USE**

This becomes Step 003. Notice that the Z dimension is measured incrementally from Step 002.

## Saving and Loading Your Programs

Programs can be *saved* in the VRO 300T. If a program is saved, it is safe from power loss. Saving and other program functions are found by pressing the

PROGRAM FUNCTIONS softkey.

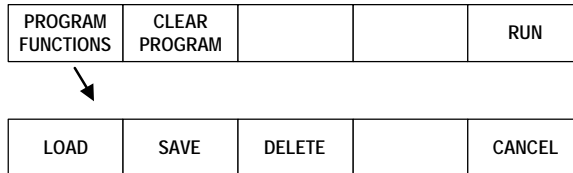

To save a program, press SAVE. Name the program using the numeric keys, or use the ALPHABET softkey to select alphabetic characters. When you have named the program, press ENTER or SAVE.

To run or edit a saved program, press the LOAD softkey. Use the arrow keys to select the program name, and press ENTER.

To clear a program which is currently on the screen, press the CLEAR PROGRAM softkey. This does **not** delete any programs which have been saved; it simply clears the program from the display.

To delete a program which has been saved, press the DELETE softkey, move to the program name, and press DELETE again.

The VRO 300T will ask you for confirmation  
before you clear or delete a program.

## Alphabet Entry

When you need to enter alphabetic characters, press the  softkey and the alphabet box appears.

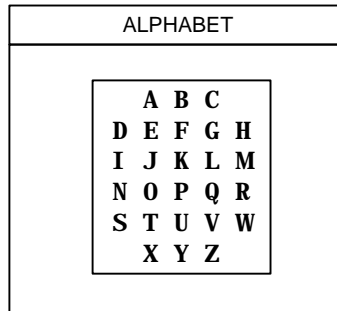



Use the softkeys to move around the alphabet, and the  key to select a letter.



You can mix alphabet characters with numerals from the keypad.

Press the  softkey again to clear the alphabet box.

## Running a Program

To run a program, move to the first step and press the  softkey. You must now *execute* the step and, when you are done, press the  softkey to run the next step.

You can run a program starting from *any* step; just move to the step you want to start with and press . Remember that Position steps are normally preceded by a Tool step that is required to calculate the correct tool offsets.

## Tool Steps

If the step is a Tool step, the new tool offsets are used and the new tool number is indicated in the status bar. Check the tool that you are using and change it if necessary.

## Position Steps

If the step is a Position step, the programmed position is automatically preset into the axis displays. The axis display is switched to incremental. You can now move to zero in each axis.

## Teaching a Position

To teach a position to the readout as you are making a part, select a step as you normally would. In any field where a position is needed, instead of entering numeric position values, machine to the position that you want to enter, then use the **TEACH POSITION** softkey to enter the position value. *Only absolute position values are used.*

### Example

The Position step below needs to have the Z1-axis entered.

FEED 0 IPM		TOOL		SCALE: 1.0000	0:00	INCH
001	POSITION	<b>X</b>	INC 0.0000	<b>1.2500</b>	ABS	RAD
POINT		<b>Z<sub>1</sub></b>	INC 0.0000	<b>0.2500</b>	ABS	
X 1.2500 ABS		<b>Z<sub>2</sub></b>	INC 0.0000	<b>0.0000</b>	ABS	
Z <sub>1</sub> <input type="text"/> ABS						
<div style="display: flex; justify-content: space-around; width: 100%;"> <span>TEACH POSITION</span> <span>CANCEL</span> <span>USE</span> </div>						

Press the **TEACH POSITION** softkey and the absolute position from the Z1 display is automatically placed in the Z1 field.

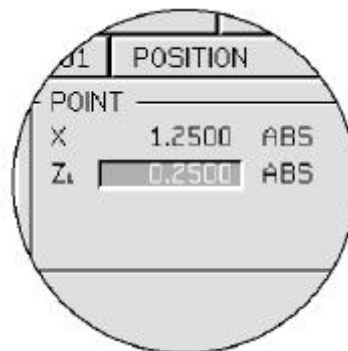

## Other Features

### Calculator

The four-function calculator keys,  $\boxed{+}$   $\boxed{-}$   $\boxed{\times}$   $\boxed{\div}$ , are available when you are in any numeric data entry field. Just use these keys as you would any calculator.

The keys will act on a number that is already in the field. For example, if you move to a field which already has a value of 3.125, and you want to double it, just press  $\boxed{\times}$   $\boxed{2}$   $\boxed{\text{ENTER}}$  to get 6.250.

When you have more than one calculation in a field, the calculator will perform multiplication and division before it does addition and subtraction.

This means that you can enter  $\boxed{3}$   $\boxed{+}$   $\boxed{1}$   $\boxed{\div}$   $\boxed{8}$  to get three and one-eighth (the  $1 \div 8$  is done before the 3 is added).

The VRO 300T can calculate trig functions, taper angles, and turning speeds. Press the  $\boxed{\text{CALC}}$  key, and the following softkeys appear.

TRIG	TAPER	RPM	CANCEL	USE
------	-------	-----	--------	-----

### Trig Functions

When you're entering data for a position function, you may need to calculate dimensions using the trig calculator. Press the  $\boxed{\text{TRIG}}$  softkey, and the following function softkeys are shown.

SHIFT	SQR ROOT	SIN	COS	TAN
	SQR	ARC SIN	ARC COS	ARC TAN

Most of the calculator softkeys are divided in half. At first, the top half is "active", while the bottom half is "inactive". Press the  $\boxed{\text{SHIFT}}$  softkey and the bottom half of the calculator options becomes active.

SHIFT	SQR ROOT	SIN	COS	TAN
	SQR	ARC SIN	ARC COS	ARC TAN

Typically, a result is calculated by entering a number and then selecting the appropriate math function. For example, to enter a number whose value is the square root of 2, press  $\boxed{\text{CALC}}$ ,  $\boxed{2}$ ,  $\boxed{\text{TRIG}}$ , and  $\boxed{\text{SQR ROOT}}$ . The value 1.4142 (the square root of 2) will be displayed. Press  $\boxed{\text{USE}}$  to accept the value.

Trig functions are calculated by entering the angle first and then the appropriate trig function. For example, enter **30**, then select the **SIN** softkey. A value of 0.5000 (sin 30°) will be displayed.

**Taper Calculator**

You can calculate tapers either by entering dimensions from a print, or by touching a tapered workpiece with a tool or indicator.

**TAPER AXES**—use the axis keys on the keypad to change the axes if needed.

**FIRST TAPER POINT**—either enter a point from the print, or touch the tool to one point and press the **TEACH POSITION** softkey, once for each axis.

**SECOND TAPER POINT**—enter a second point on the taper.

**TAPER ANGLE**—is automatically calculated.

TAPER CALCULATOR			
TAPER AXES			
FIRST AXIS		X	
SECOND AXIS		Z1	
FIRST TAPER POINT			
X	0.5000	ABS	
Z1	0.0000	ABS	
SECOND TAPER POINT			
X	0.7500	ABS	
Z1	3.2500	ABS	
TAPER ANGLE			
X	85.6014	DEG	
Z1	4.3987	DEG	

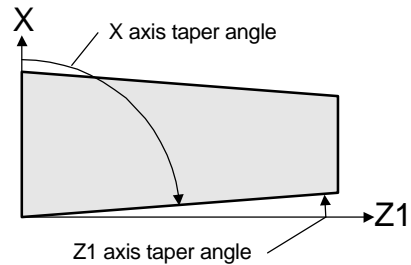
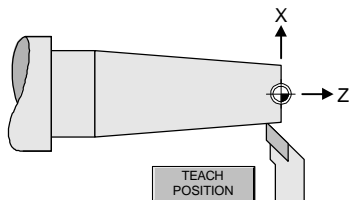
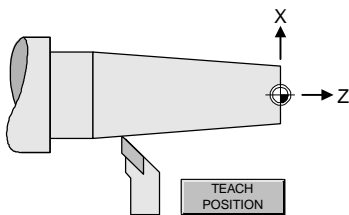
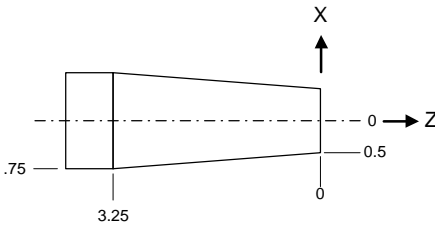



### RPM Calculator

This feature lets you calculate the correct rotational speed based on the diameter you are cutting and the desired surface speed.

**DIAMETER**—enter the workpiece diameter. You can change to metric with the **MM** key.

**SURFACE SPEED**—enter the desired surface speed. You can change between feet/minute and meters/minute using the softkeys. For convenience, the **SURFACE SPEED TABLE** softkey brings up a table of surface speeds for various material.

**RPM**—is calculated automatically.

RPM CALCULATOR	
DIAMETER	2.000 INCH
SURFACE SPEED	150 FT/MIN
RPM	286

## Printing



If you have a printer connected to the VRO 300T, you can have the readout print various pieces of information. Softkeys are available whenever there is something that you can print.

**POSITION**—when the axis positions are displayed, press the  softkey to print the positions.

The current tool number is printed before the position. The absolute and incremental positions for each displayed position is printed with the units of measure. Also, the crossfeed axis will indicate if the position is a radius or a diameter value.

```

TOOL: #2
X ABS           2. 9710
INCH DIA
INC           2. 9710
INCH DIA
Z1 ABS       0. 0435
INCH
INC         - 1. 8260
INCH
  
```

**PROGRAM**—when the program list is visible, you can press , then the  softkey to print out each step of the program.

Some setup information, such as scale factor, prints here.

```

PROGRAM NAME: PART100
DIMENSION UNITS = INCH

001 SET TOOL
NUMBER = 2
X = 1. 2500
INCH
Z1 = 0. 5440
INCH

002 POSITION
X = 0. 0000
ABS DIA
Z1 = 0. 5000
  
```

TOOL LIBRARY—when you are looking at the tool library, press the  softkey to print a copy of it.

TOOL LIBRARY		
NUMBER	X OFFSET	Z
00	0.5020	
0.0021	INCH	
01	0.2953	-
1.3822	INCH	
05	2.0030	

SYSTEM PARAMETERS—the  softkey is displayed in the Job Setup screen. Both job-related and machine-related parameters are printed.

JOB SETUP PARAMETERS	
DISPLAY RESOLUTION	
X =	0.0005 INCH
Z1 =	0.0005 INCH
SCALE FACTOR	
	1.0000
NEAR ZERO WARNING	
Y -	OFF

## Remote Interface

You can enter commands into the VRO 300T from a remote terminal or computer if you have configured the serial port as a COMPUTER. These remote commands are in the form of ANSI standard ASCII characters. The remote device can request that the readout send information, such as the current position, or the device can control the readout by simulating the pressing of any of the readout's hard keys or softkeys.

### Requesting Information

Commands that request information from the readout begin with the question mark character. As soon as the command is recognized, the response data is sent, terminated by a CR character. Invalid commands are ignored.

String	Command	Response
?*	Reset	No information returned. Resets the echo flag and input and output buffers.
?En	Set Echo Mode: echo when a keypad command is sent.	<i>n</i> is equal to 0, 1, or 2. If <i>n</i> = 0, no echo. If <i>n</i> = 1, echo the control character sent. If <i>n</i> = 2, echo a string describing the key function. Refer to the "Readout Keypress" column in the Keypad Command table on page 30 for the strings.
?Ix  ?Ax	Get Incremental Position  Get Absolute Position	Returns the position for the axis specified. <i>x</i> = 1, 2, 3, 4, 5 or 6. Examples are: "X= -123.4567 INCH", "Z1= +123.4567 INCH"  For an undefined axis, the response is "** = ****. **** **". If an error exists, the response is: "x = Error mm".
?U	Get Units	Returns the current display units, "INCH" or "MM".
?X	Get Active Axes	Returns the displayable axes. Response is "X Z1 Z2 Y ** **". "***" means axes are not displayed.
?T	Get Current Tool	Returns the number for the current tool (0-99).
?Q	Get Port Status	Verifies the operation of the port connected to the computer. The responses are: 0 = No parity, data overrun, or buffer overflow errors have occurred since the last "port status" check. 1 = One of the above errors has occurred since the last "port status" check.

## Keypad Commands

Sending one of the control characters from the following table to the readout is equivalent to pressing the corresponding readout key.

Control Character	Readout Keypress
Q	X
W	Z1
E	Z2
R	Y
A	ZERO X
S	ZERO Z1
D	ZERO Z2
F	ZERO Y
!	SOFT KEY 1
@	SOFT KEY 2
#	SOFT KEY 3
\$	SOFT KEY 4
%	SOFT KEY 5
Z	TOOL
X	POS
T	DRO
Y	PGM
U	RAD/DIA
I	INFO
O	SET UP
G	ABS/INCR
H	MM
J	CALC
0	0
1	1
2	2

Control Character	Readout Keypress
3	3
4	4
5	5
6	6
7	7
8	8
9	9
.	. (decimal)
_ (underscore)	+/-
[	CLEAR
]	ENTER
+	+
-	-
*	x (multiply)
/	÷
<	UP ARROW
>	DOWN ARROW

## Job Clock

The job clock can help you estimate jobs or monitor throughput. It records to the nearest minute. You can start, stop, and reset the job clock using the softkeys in Setup. Refer to page 43.



## Reference Tables

Several useful tables, including thread sizes and machine cutting speeds, are included in the VRO 300T. Press the **INFO** key, then the **INDEX** softkey to see the index of topics. Move to REFERENCE TABLES and press the **ENTER** key.

## Setup

The **SETUP** key lets you change the system parameters. Some of these parameters are job related, meaning that they may change from job to job. Others are machine related and should be set as part of the installation. The machine-related parameters can be accessed by pressing the **INSTALLATION SETUP** softkey and entering the access code.

Use the **↑** **↓** keys to move from one parameter to the next, and the **ENTER** key to select the parameter.

The **USE NEW SETTINGS** softkey will terminate the setup process and save the changes.

Press the **CANCEL CHANGES** softkey to cancel the changes.

JOB SETUP	INSTALLATION SETUP
TOOL LIBRARY	DISPLAY CONFIGURATION
DISPLAY RESOLUTION	ENCODER SETUP
SCALE FACTOR	SERIAL PORT
NEAR ZERO WARNING	PARALLEL PORT
ERROR COMPENSATION	PROTECTION
JOB CLOCK	DIAGNOSTICS
FEED UNITS	
REMOTE SWITCH	
VECTORING	

## Job Setup

### Setting Up the Tool Library

The VRO 300T can store the dimensional offsets for up to 100 tools. When you change a workpiece and establish the absolute zero, all the tools are automatically referenced from the new workpiece zero.

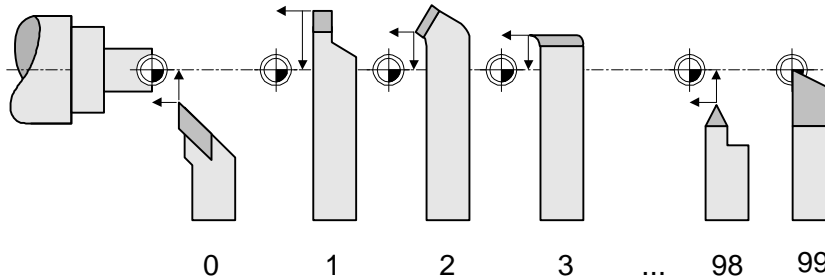

The offset dimensions can be determined using a tool presetter, or you can use the *auto-offset calculation* feature of the readout. Press the **OFFSET METHOD** softkey and select the method you wish to use.

### Defining Tools with Auto-Offset

Use the arrow keys to select the tool you want to qualify. Press the **ENTER** key.

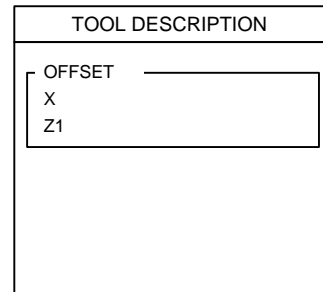

### Crossfeed Axis:

1. Install the tool and machine a diameter.
2. While the tool is still in contact with the workpiece, press the **LOCK AXIS** softkey. The readout will remember this tool position, even if you move the tool.
3. Move the tool away from the workpiece and measure the diameter.
4. Enter the measured value.

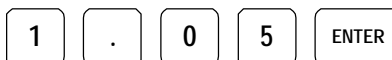
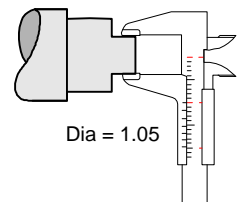
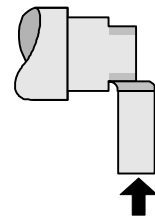



*Longitudinal Axis:*

1. Make a face cut.

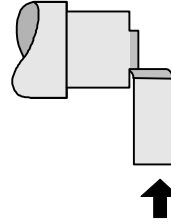

2. While the tool is still in contact with the workpiece, press the **LOCK AXIS** softkey.
3. Move the tool away from the workpiece and measure the face location.

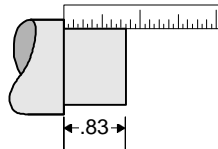

4. Enter the measured value.

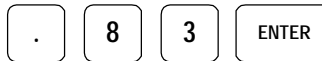

5. Press the **DONE** softkey to save the tool offset.

Repeat the above procedure for each tool you want to use. As your tools wear, you will begin to see differences between the readout display and workpiece dimensions. From time to time you will need to check or re-qualify your tools.

**A Tool Library Strategy**

You do not need to have *all* tools referenced to each other—you can have different *groups* of tools. For example, you may have qualified tools 10 through 20 on a tool presetter, and tools 50 through 60 using the auto-offset method. To use the first group of tools, install any one of them, say tool 15, and use it to set absolute zero. Now, tools 10 through 20 are referenced to the same zero location. To use the second group of tools, use any one of *them*, say tool 50, to set absolute zero, and now tools 50 through 60 will be correctly referenced.

## Display Resolution

The display resolution will normally be the same as the encoder resolution. However, if the job tolerance is coarser than the encoder resolution (for example, the job tolerance may be  $\pm 0.005$ "), you can adjust the display resolution so you won't be tempted to waste time by machining to a finer resolution.

Use the  and  softkeys to cycle through all the possible choices. The choices available depend upon the resolutions of the encoders.

If the axis is a crossfeed axis, you can press the  key to see what the display resolution will look like as either a radius or a diameter.

DISPLAY RESOLUTION	
X AXIS	0.0005 DIA
Z1 AXIS	0.001
Z2 AXIS	0.0005
Y AXIS	0.0005
U AXIS	
V AXIS	

## Near Zero Warning

Each axis has its own near zero warning range. You can activate or deactivate the near zero warning feature by pressing the  and  softkeys. When the warning is activated, you can enter the range.

The warning indicator appears in the display just before the tool enters the range, and it begins to move when the tool enters the range. The indicator moves faster as it approaches zero. Refer to page 15.

NEAR ZERO WARNING	
X AXIS	0.010
Z1 AXIS	0.020
Z2 AXIS	OFF
Y AXIS	OFF
U AXIS	OFF
V AXIS	OFF

## Linear Error Compensation

The VRO 300T includes a linear error compensation feature that enables you to compensate for machine tool inaccuracies. You can have up to 99 different compensation segments per encoder.

In order for linear error compensation to function properly, the readout needs to be able to establish the segment boundaries in the same physical locations each time you turn on the readout. This means that you must find the encoder's reference mark. Refer to page 6, "Power-On Position Recovery".

To begin the process, select **ERROR COMPENSATION** from the **JOB SETUP** list. Error compensation is applied to each encoder individually, so you must first select the axis that you want to work with. You may use a display axis key (**X** for example) to select the encoder, unless the encoder is coupled with another one, or the encoder is displayed as the U or V axis. If that is the case, enter the number of the input that the encoder is connected to.

Examples:

- X axis displays encoder 1; you may press **X** or **1** to select this encoder.
- Z1 axis displays encoders 2 + 3; you may press **Z1** or **2** to select encoder 2, but you **must** press **3** to select encoder 3.

Once you have selected the encoder, the readout displays the error compensation table for that encoder. Initially, there is only one segment defined, and it applies from one end of the encoder to the other.

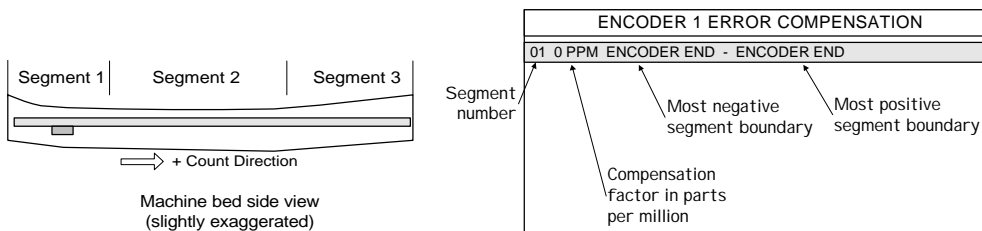

The following softkeys let you begin defining the table.

ENTER COMP	CALCULATE COMP	ANCHOR SEGMENT 1		DONE
---------------	-------------------	---------------------	--	------

### Anchoring the Segments

If you *anchor* the beginning of the first segment at a known location on the encoder, then the segment boundary values will be the actual physical distances from the anchor point, as shown below.

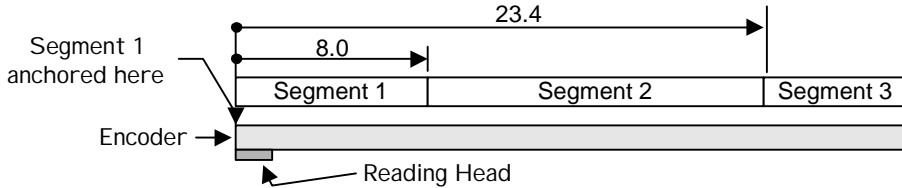

ENCODER ERROR COMPENSATION			
01	492 PPM	ENCODER END --	8.00
02	-697 PPM	8.00 --	23.40
03	-78 PPM	23.40 --	ENCODER END

Anchoring the segments is optional: if you don't do it, the segment boundary values may be meaningless to you (although they are understood by the readout).

**ANCHOR SEGMENT 1**

Pressing this softkey puts the start of Segment 1 at the current tool location. To anchor the segments correctly, move the encoder

in the negative count direction as far as it will go, then press **ANCHOR SEGMENT 1**.

*Note:* If you anchor Segment 1 in a different place *after* you have established the compensation values, then the entire compensation table will be shifted to the new anchor location, as shown below.

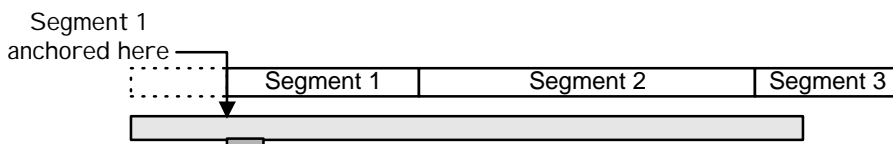
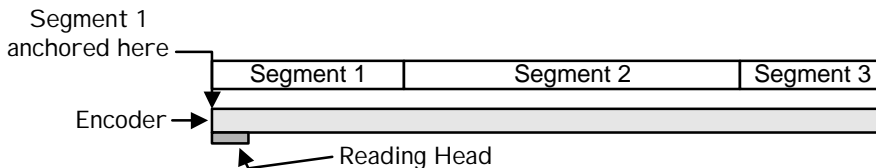

## Compensation Entry Methods

You can enter the segment boundaries and compensation factors using the keypad, or you can have the readout calculate them for you. Normally, you would use the keypad entry method only to restore or adjust a known compensation value.

### Manual Entry

**ENTER  
COMP**

This brings up the softkeys needed to let you enter compensation and segment information using the keypad.

NEW SEGMENT	CLEAR TABLE	ANCHOR SEGMENT 1	CANCEL	DONE
----------------	----------------	---------------------	--------	------

The **NEW  
SEGMENT** softkey brings up the DEFINE SEGMENT form.

**FACTOR**—Enter the compensation factor in parts per million.

**SEGMENT**—You can change the TO field only. Use the **ENCODER  
END** softkey if the boundary is at the

end of the encoder. Use the **POINT** softkey to enter the physical location of the boundary. The current reading head location may also be entered using the **TEACH  
POSITION** softkey.

DEFINE SEGMENT	
FACTOR	2 PPM
SEGMENT	
FROM	ENCODER END
TO	ENCODER END

The **DONE** softkey saves the segment information in the table.

Continue adding segments with the **NEW  
SEGMENT** softkey. You must add them in order, from the encoder's most negative end to its most positive end.

The **CLEAR  
TABLE** softkey will delete the information from the table, erasing all segments and compensation factors, so that the readout will not perform any error compensation.

**Calculated Entry**

CALCULATE  
COMP

This brings up the softkeys needed to have the readout calculate the compensation factors.

NEW SEGMENT	CLEAR TABLE	ANCHOR SEGMENT 1	CANCEL	DONE
----------------	----------------	---------------------	--------	------

The NEW  
SEGMENT softkey brings up the CALCULATE SEGMENT form.

**STANDARD**—This is where you enter the actual length of the standard.

**TRAVEL**—Shows the measured length of the standard. This would normally be slightly different from the actual length because of machine inaccuracies.

**FACTOR**—This is the compensation factor calculated by the readout.

CALCULATE SEGMENT	
STANDARD	0.0000
TRAVEL	0.0000
FACTOR	0000 PPM

You will need a dial indicator and a measurement standard.

1. Position the standard in the center of the segment.
2. Enter one edge of the standard.

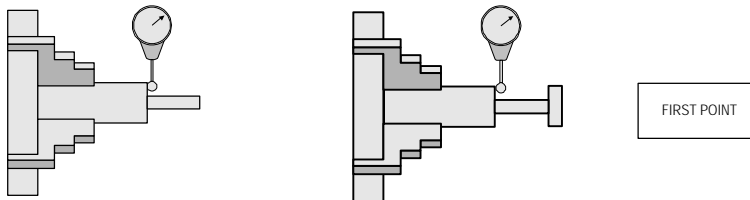

3. Enter the other edge of the standard.

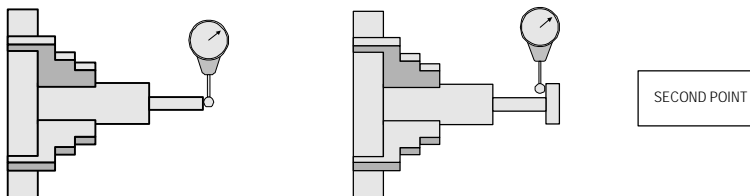

4. Enter the actual size of the standard, including the probe diameter if necessary.

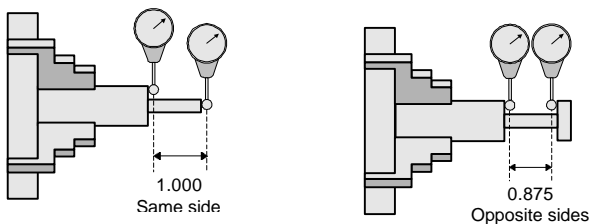

If the calculated factor is 9999 or -9999, the machine inaccuracy is too great and cannot be compensated.

5. Press  to save the segment information into the table.

The readout will automatically set the segment boundaries between the current segment and adjacent segments.

## Feed Rate Units

Use the  and  softkeys to change the feed rate units between inches per minute and mm per minute.

## Remote Switch

The external switch (pendant or footswitch) can be enabled to perform any or all of the following functions:

**PRINT**—print the current position. Enable the print function with the  softkey, disable it with the  softkey.

**ZERO**—zero one or more axes. Use the axis keys ( for example) to specify which axes you want to zero when the switch is pressed.

**NEXT**—run the next program step. The  and  softkeys enable or disable this function.

REMOTE SWITCH	
PRINT	<input type="text" value="NO"/>
ZERO	<input type="text" value="XZ1"/>
NEXT	<input type="text" value="NO"/>



## Vectoring

*Vectoring* breaks down the movement of the compound axis into the crossfeed or longitudinal axes. If you are turning threads, for example, vectoring lets you see the diameter of the thread in the X-axis display, even though you are moving the cutting tool with the compound axis handwheel.

With vectoring enabled, you can preset the desired radius or diameter in the X axis, so that you can “machine to zero”.

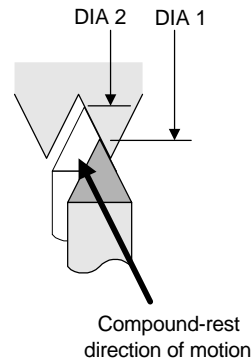

When vectoring is used with the VRO 300T, the compound axis encoder must be assigned to the Y axis display (it can be assigned to other displays as well—refer to page 44). The crossfeed component of movement of the Y-axis will then be shown in the X-axis display. The longitudinal component of movement of the Y-axis will be shown in the Z1-axis display, the Z2-axis display, or both.

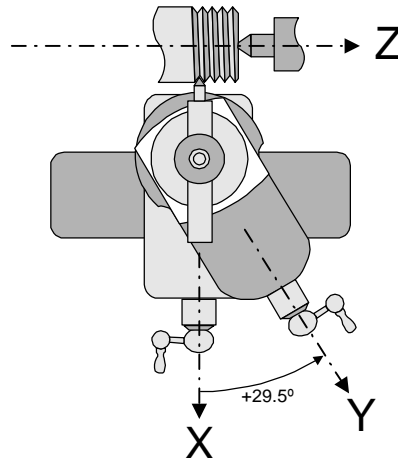

Select VECTORING from the JOB SETUP list.

**STATUS**—use the  ON and  OFF softkeys to enable or disable the vectoring feature. The X and Z axis displays will indicate when vectoring is enabled, and the Y axis will display the angle of the compound axis.

**Z COMPONENT**—use the  Z1 and  Z2 keys to select which Z-axis display to use for the longitudinal axis.

**ANGLE**—enter the angle between the X and Y axes, as indicated in the diagram above.

VECTORING	
STATUS	<input type="checkbox"/> ON
Z COMPONENT	<input type="checkbox"/> Z1
ANGLE	29.500

## Scale Factor

The scale factor can be set to scale the workpiece up or down from the preset or programmed size. All preset and displayed dimensions are multiplied by this scale factor. All programmed dimensions will be multiplied by this scale factor when the program is run. The numbers in your program are not changed.

A scale factor of 1.000 causes the readout to use preset or programmed dimensions exactly. Values greater than 1 cause parts to be made larger; values less than 1 cause parts to be made smaller.

SCALE FACTOR	
SCALE	1.0000

### Example:

For a scale factor that allows for 3% material shrinkage, use this formula:

$$\text{ScaleFactor} = \frac{1}{1-.03} = \frac{1}{.97} = 1.0309$$

## Job Clock

The softkeys let you start and stop the job clock, and let you reset it to zero. The actions do not take effect until you leave setup with the  softkey.

JOB CLOCK	
ELAPSED TIME	1:38
RUNNING	

## Installation Setup

### Display Configuration

Individual encoders are connected to the VRO 300T at inputs numbered 1 through 6. The assignment of each encoder to an axis display (X, Z1, or Y for example) is done by completing this form.

Each axis display can be configured in one of the following ways.

*Unused*—press the  softkey to delete the axis from the DRO display.

*Single Encoder*—use the numeric keypad to enter the encoder input number.

*Coupled Encoders*—you can couple two encoders together using the , , or  keys:

will display the sum of encoders 1 and 2.

will display the difference between encoders 1 and 2.

will display the average of encoders 1 and 2.

DISPLAY CONFIGURATION	
X DISPLAY	<input type="text" value="1"/>
Z1 DISPLAY	<input type="text" value="2"/>
Z2 DISPLAY	<input type="text" value="3"/>
Y DISPLAY	<input type="text" value="3"/>
U DISPLAY	<input type="text" value="2+3"/>
V DISPLAY	<input type="text" value="OFF"/>

You can display the same encoder in more than one axis.

In the above example, the X, Z1, and Z2 displays show encoders 1, 2, and 3 respectively. The Y-axis display will also show encoder 3, and the U-axis display couples the movements of encoders 2 and 3 together (for example, when the compound axis is parallel to the longitudinal axis). The V display will not appear.

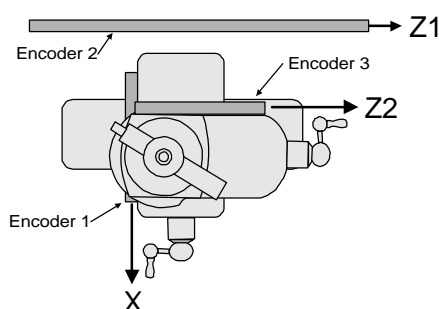
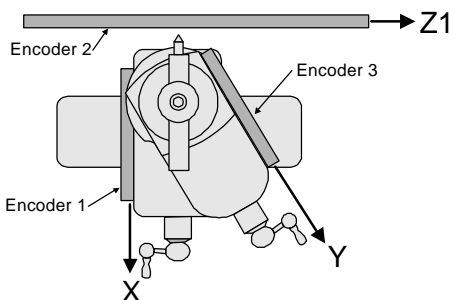

## Encoder Setup

You must tell the readout something about the encoders. Select ENCODER SETUP from the Installation Setup list and enter the encoder number (the number is defined by the input connector number on the back panel of the readout).

The encoder number you selected is shown at the top of the form.

**RESOLUTION**—first use the softkeys to select between linear and angular movement.

*Linear*—move the corresponding machine axis in a positive direction until the readout senses and displays the resolution. You won't have to move more than two inches. For encoders without Position-Trac, enter the resolution in microns ( $\mu\text{m}$ ).

*Angular*—for an encoder used to measure angular position, enter the number of counts per revolution.

**DIRECTION**—you can change the count direction with the  and  softkeys.

**AXIS TYPE**—select either longitudinal or crossfeed. A crossfeed axis will be able to display position either as a diameter or as a radius. Just press the   key to select which way you want to display it.

ENCODER 1 SETUP	
RESOLUTION	10.0000 UM
DIRECTION	POSITIVE
AXIS TYPE	LONGITUDINAL

## Serial Port

You can configure the serial port to connect to a printer or to a computer. Check the specifications for your printer or computer to determine how to complete the following information. For most items, the softkeys will provide you with the available choices.

**FUNCTION**—identifies what you're communicating with, a printer or a computer. Press  to disable the serial port.

**OUTPUT TAIL**—enter the number of blank lines (CR character), from 0 to 9, that you want to print after the information is sent.

**LF AFTER CR**—press  if you want to output a line feed character after the carriage return (end of line).

**BAUD**—press the  and  keys to cycle through the available information transmission speeds (baud rate).

**PARITY**—select none, even, or odd.

**DATA BITS**—use the softkeys to select 7 or 8 bit word length.

**STOP BITS**—use the softkeys to select 1 or 2 stop bits.

SERIAL PORT	
PORT CONFIGURATION	
FUNCTION	<input type="button" value="PRINTER"/>
OUTPUT TAIL	0
LF AFTER CR	NO
PORT PROTOCOL	
BAUD	1200
PARITY	NONE
DATA BITS	8
STOP BITS	1

## Parallel Port

Most printers connect to the parallel port. You can experiment with these settings to format the printed output.

**FUNCTION**—select  OFF to disable the port or  PRINTER to enable it for printing.

**OUTPUT TAIL**—enter the number of blank lines (CR character), from 0 to 9, that you want to print after the information is sent.

**LF AFTER CR**—press  YES if you want to output a line feed character after the carriage return (end of line).

PARALLEL PORT	
PORT CONFIGURATION	
FUNCTION	<input type="checkbox"/> PRINTER
OUTPUT TAIL	0
LF AFTER CR	NO

## Protection

You have the ability to prevent changes to your part programs and to your tool library *without first entering into the INSTALLATION SETUP and disabling the protection.*

With program protection set to YES, programs cannot be changed or saved. This reduces the likelihood that an inexperienced operator will inadvertently make scrap parts by mistakenly changing or deleting a program step.

PROTECTION	
PROGRAM	<input type="checkbox"/> NO
TOOL LIBRARY	<input type="checkbox"/> YES

If you protect the tool library, it can't be mistakenly changed either.

## Installation

### IMPORTANT

Before installing the VRO 300T readout, record the serial number on the warranty card and return it to ACU-RITE INCORPORATED. The serial number label is located on the back of the readout.

### Selecting a Location

Selecting a location for the readout is an important consideration for proper installation. Keep the following points in mind when selecting a safe and convenient location:

- The readout should be within reach of the operator for easy access to the keypad.
- The readout should be approximately at eye level.
- Avoid moving components or tools and minimize coolant splash or spray.
- The operating environment must be within the temperature range of 0° to 40°C (32° to 104°F) with a non-condensing relative humidity of 25% to 85%.

### Proper Mounting

ACU-RITE has developed special mounting kits for the readout which address the most common mounting requirements. Mounting kits include:

- Column and base machine mountings
- Hardware and mounting instructions

These kits are available from your factory authorized ACU-RITE Distributor or OEM/OEI.

If you fabricate a support device for the readout, it should be large enough and strong enough to accommodate the readout. It must also be stiff enough to minimize any vibration induced by machinery on the shop floor.

## Connecting the Encoders

Insert the connector from each encoder into the mating connector on the back of the readout. Fasten it with a small screwdriver.

Provide enough slack in the encoder cables to allow for full travel of all machine axes. Check that machine movements will not pinch the cables. Use the cable tie-down hardware kits supplied with the encoders to fasten the cables neatly to the machine.

## Connecting a Ground Wire

Connect a ground wire from the terminal on the back of the readout to the machine. The machine should also be connected to a solid earth ground. If not, be sure that the readout is.

## Checking Voltage and Connecting Power



### CAUTION

Connecting the readout to a power source outside of the acceptable range may damage the readout, the encoders, or both.

Check that the voltage available at the power source is within specification before connecting it to the readout. Refer to page 50.

Connect the readout to the power source using the power cord supplied.



## Readout Specifications

Characteristic	Specification
Operating conditions	0° to 40°C (32° to 104°F) 25% to 85% relative humidity (non-condensing)
Storage conditions	-40° to 60°C (-40° to 140°F) 25% to 95% relative humidity (non-condensing)
Input requirements Voltage: Frequency: Current:	95 – 264 VAC single phase 47-63 Hz 350ma @115V, 200ma @230V
Fuse	¼ A, 250V, 3AG, Slo-blo
Encoder input	Position signals: channels A & B TTL square wave signal in quadrature (90° nominal phase relationship) Maximum input rate: 50 KHz Reference signal: TTL square wave
Control Function Interface (CFI)	Compatible with ACU-RITE CFI box
Edge finder input	Compatible with ACU-RITE electronic edge finder
Touch probe input	Compatible with Heidenhain touch probe
Ext. video output	VGA 640 x 480 pixels
Pendant input	Compatible with ACU-RITE
Parallel port	IEEE 1284-A for standard PC printer
Serial port	EIA/TIA-232E, V.28, RS-232C compatible
Size	8.375"H x 15.25"W x 10"D
Weight	17 lbs.
Mounting	Bottom: two ¼ -20 threaded inserts
FCC compliance	Class A

## Troubleshooting

This section is intended to provide you with some basic troubleshooting assistance with your readout system. If you cannot correct the problem after following these instructions, contact your authorized ACU-RITE distributor or OEM/OEI for repair or replacement procedures.

### No Operation

#### NOTICE

If you turn power off, you must wait at least 5 seconds before turning it back on, or the readout may not power up. This is because the power supply, in order to withstand brief power outages and brownouts, requires several seconds to reset itself.

If the readout display will not operate, check the following conditions:

- **Check AC power source.** If the readout cannot be powered up, confirm that line voltage is present at the source and that the line voltage meets the required specifications.
- **Check power cord.** Remove the power cord at the electrical input module on the back of the readout. Determine if line voltage is present at this end of the cord.

- **Check fuse.** With the power cord removed, use a thin straight-blade screwdriver to remove the cover of the electrical input module. Slide out the fuse holder and check the fuse. If necessary, replace it. Replace the input module cover by snapping it back into place, and reconnect the power cord.

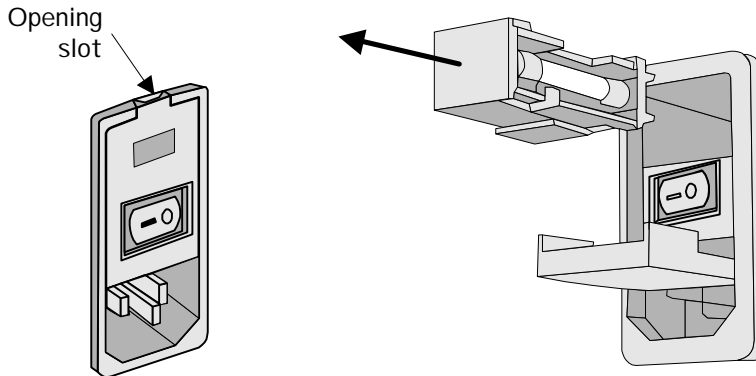

### CAUTION

Replace fuses only with the specified type. Using incorrect fuses can present a safety hazard. The readout may also be permanently damaged. Refer to the Readout Specification chart on page 50 for the correct fuse.

### Incorrect Operation

If system positioning does not seem to be repeatable, the problem could be with the machine tool or with the readout system.

- **Check the machine tool.** Check that the saddle is not locked. Ensure that the turret-to-column bolts are properly secured. Check the gib adjustments. Check spindle run-out.
- **Check linear encoders.** Check each encoder and reading head for proper installation. Ensure that the mounting brackets are secure.

If the system seems to be displaying incorrect positions, check the following items.

- **Verify presets.** Make sure that the numbers you entered are correct.
- **Verify tool.** Check that the correct tool number is being used. Make sure the correct tool offset has been entered. Check the tool for wear.
- **Verify the scale factor.** Ensure that the correct scale factor is being used.
- **Verify linear error compensation.** Make sure that the factors used for linear error compensation are correct.

## Errors

The readout includes built-in test and error-checking circuitry. This circuitry identifies errors that occur, and reports the problem to the operator.

**Loss of power** is indicated by the “Power was off” message. Loss of power means that power to the readout has been interrupted. Since power to the encoders has also been interrupted, position information may no longer be accurate. Press the  key to clear the error message. Refer to page 6 for information about position recovery.

**Counting errors** are indicated by the “Scale miscount” message, telling you in which axis the miscount occurred. Counting errors result from distorted electrical signals from an encoder. These signals can be a result of an encoder malfunction, misalignment, mounting problems, or electrical interference.

Press the  key to clear the error message. Follow these steps to determine if your difficulties are associated with the readout or with the encoder.

- Ensure that the linear encoder connectors are correctly seated.
- Swap linear encoder cables at the readout to see if the problem still appears in the same display.
- If the problem remains in the same display, the readout is in error.
- If the problem follows the connection change, the linear encoder may be in error. Refer to the **Checking the Linear Encoders** section of your encoder reference manual.

**Display overflow errors** are indicated by a blank axis display. A numeric overflow occurs when the intended measurement is too large for the eight-digit display. Clear the error by returning the machine table into an area where measurements can again be displayed, setting a new preset or zeroing the display.

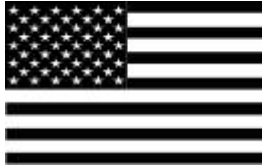

**ACU-RITE Readout Systems are  
manufactured in the USA**

ACU-RITE IS AN  
**ISO 9001**  
**CERTIFIED**  
MANUFACTURER

***ACU-RITE***<sup>®</sup>

ACU-RITE INCORPORATED  
ONE PRECISION WAY  
MASON INDUSTRIAL PARK  
JAMESTOWN, NEW YORK 14701